

Reference Only

Block Type EMIFIL BNX00□-11 Reference Specification

1. Scope

This reference specification applies to Block Type EMIFIL.

2. Rating

| Customer Part Number | Murata Part Number | Rated Voltage V(DC) | Withstanding Voltage V(DC) | Rated Current A(DC) | Insulation Resistance MΩmin. | Voltage Drop mV max. | Insertion Loss dB min. |
|----------------------|--------------------|---------------------|----------------------------|---------------------|------------------------------|----------------------|------------------------|
| | BNX002-11 | 50 | 125 | 10 | 100 | 30 | 1 MHz to 1 GHz: 40 |
| | BNX003-11 | 150 | 375 | 10 | 100 | 30 | 5 MHz to 1 GHz: 40 |
| | BNX005-11 | 50 | 125 | 15 | 100 | 30 | 1 MHz to 1 GHz: 40 |

- Operating Temperature -40°C to +85°C
- Storage Temperature -40°C to +85°C

3. Standard Testing Condition

<Unless otherwise specified>

Temperature : Ordinary Temp. 15 °C to 35 °C
 Humidity : Ordinary Humidity 25 %(RH) to 85 %(RH)

<In case of doubt>

Temperature : 20 °C ± 2 °C
 Humidity : 60 %(RH) to 70 %(RH)
 Atmospheric pressure : 86 kPa to 106 kPa

4. Style and Dimensions

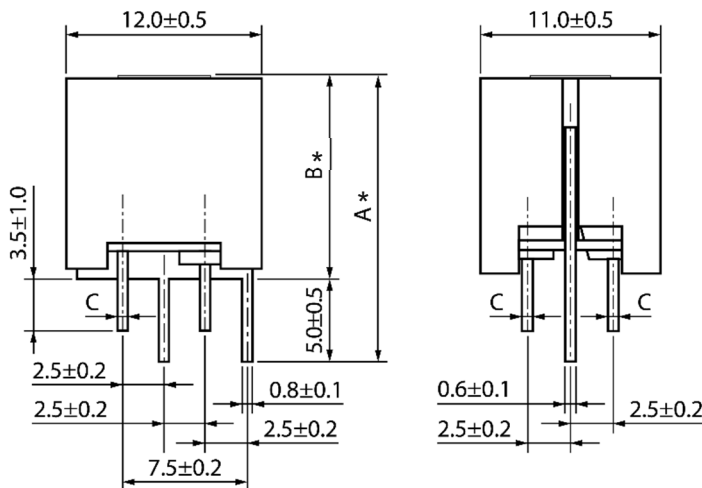

| Part Number | A | B | C |
|-------------|-----------|-----------|--------|
| BNX002-11 | 18.0 max. | 12.5 max. | (ø0.8) |
| BNX003-11 | 18.0 max. | 12.5 max. | (ø0.8) |
| BNX005-11 | 18.0 max. | 13.0 max. | (ø1.0) |

(in mm)

*The upper one between the top of the case and the surface of the capacitor is adopted in the measurement of the height of the product.

Note) Although some part of the product surface seems to be white in some cases, do not care because it is the result of waxing process for humidity resistance improvement. This wax does not make bad affection to mechanical or electrical performance, reliability of the product.

• TERMINAL LAYOUT (BOTTOM FIGURE)

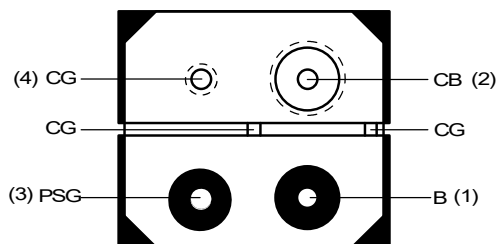

• DIMENSIONS OF INSTALLATION HOLES

(front view)

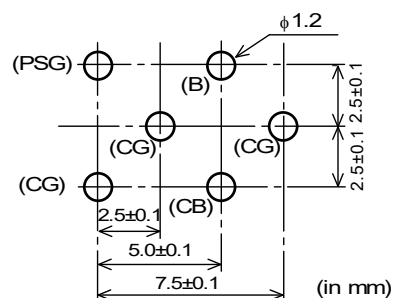

(in mm)

Reference Only

• EQUIVALENT CIRCUIT

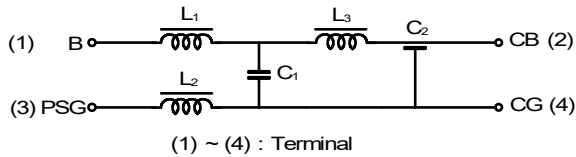

- Unit Mass (Typical value)
- BNX002-11 3.0g
- BNX003-11 3.2g
- BNX005-11 3.3g

5. Marking

Filter shall be marked as follows.

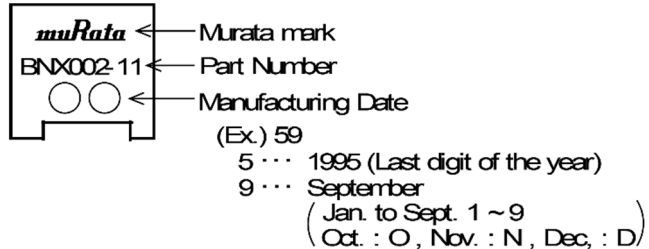

6. Electrical Performance

| No. | Item | Specification | Test Method |
|-----|-----------------------|-----------------------------|---|
| 6.1 | Insulation Resistance | Meet item 2. | Measured at DC rated voltage between terminal (1)(2) and (3)(4). Time: 1 minute Suitable resistor: 1MΩ. |
| 6.2 | Withstanding Voltage | Filter shall be no failure. | Voltage shall be applied between terminal (1)(2) and terminal (3)(4). Time : 1 to 5 seconds. Charging current : 50 mA max. |
| 6.3 | Voltage Drop | Meet item 2. | Rated Current: 10 A (BNX002-11, BNX003-11) 15 A (BNX005-11) |
| 6.4 | Insertion Loss | Meet item 2. | *Method of measurement based on MIL-STD-220 Insertion Loss = 20log (E ₀ / E ₁) E ₀ : Level without FILTER (short) E ₁ : Level with FILTER |

7. Mechanical Performance

| No. | Item | Specification | Test Method |
|-----|---------------------------|------------------------------------|---|
| 7.1 | Appearance and Dimensions | Meet item 4. | Visual Inspection and measured with Slide Calipers. |
| 7.2 | Marking | Marking is able to be read easily. | It is inspected Visually. |

Reference Only

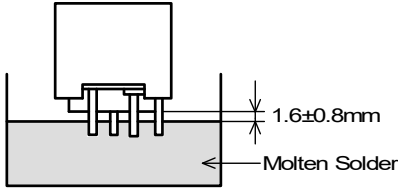
| No. | Item | Specification | Test Method | | | | | | | | |
|-----------------------|------------------------------|--|---|------------|-----------------------|------------|---------------------|------------|----------------|--------------|---|
| 7.3 | Vibration | Meet Table 1. <u>Table 1</u> <table border="1" style="width: 100%; border-collapse: collapse; margin-top: 5px;"> <tr> <td style="width: 50%;">Appearance</td> <td>No damaged</td> </tr> <tr> <td>Insulation Resistance</td> <td>30 MΩ min.</td> </tr> <tr> <td>Dielectric Strength</td> <td>No failure</td> </tr> <tr> <td>Insertion Loss</td> <td>Meet item 2.</td> </tr> </table> | Appearance | No damaged | Insulation Resistance | 30 MΩ min. | Dielectric Strength | No failure | Insertion Loss | Meet item 2. | It shall be soldered on the substrate. Range of Vibration Frequency : 10 to 2000 to 10Hz for 20 minutes Testing Time: A period of 2 hours in each of 3 Mutually perpendicular directions (Total 6 hours) Double Amplitude: 1.5mm or acceleration 196m / s ² Then measured after exposure in the room condition for 4 to 24 hours. |
| Appearance | No damaged | | | | | | | | | | |
| Insulation Resistance | 30 MΩ min. | | | | | | | | | | |
| Dielectric Strength | No failure | | | | | | | | | | |
| Insertion Loss | Meet item 2. | | | | | | | | | | |
| 7.4 | Solderability | Then the lead is covered with a continuous new solder coating at least 75% along the circumference of the immersed part. | Flux: Ethanol solution of rosin, 25(wt)% Pre-heat: 150 ± 10 °C, 60 ~ 90 s Solder: Sn-3.0Ag-0.5Cu Solder Temperature: 245 ± 5 °C Immersion Time: 2 ± 0.5 seconds  | | | | | | | | |
| 7.5 | Resistance to soldering heat | Meet Table 1. | Flux : Ethanol solution of rosin, 25(wt)% Pre-heat: 150 ± 10 °C, 60 ~ 90 s Solder: Sn-3.0Ag-0.5Cu Solder Temperature: 270 ± 10 °C Immersion Time: 10s (+ 2s , - 0s) Then measure values after exposure in the room condition for 24 to 48 hours. | | | | | | | | |
| 7.6 | Resistance to soldering iron | | Solder: Sn-3.0Ag-0.5Cu Tip Temperature: 350 ± 10 °C Time: 4 ± 1 s Then measure values after exposure in the room condition for 24 to 48 hours. | | | | | | | | |

8. Environmental Performance

| No. | Item | Specification | Test Method |
|-----|-------------------|---------------|--|
| 8.1 | Temperature Cycle | Meet Table 1. | 1 Cycle 1 step: - 40 °C (+ 0°C , - 3°C) / 30 minutes 2 step: Room Temperature / within 5 minutes. 3 step: + 85 °C (+ 3°C , - 0°C) / 30 minutes 4 step: Room Temperature / within 5 minutes. Total of 10 cycle Then measured after exposure in the room condition for 24 to 48 hours. |
| 8.2 | Humidity Life | | Temperature: 40 ± 2 °C Humidity: 95 %(RH) Applying Voltage: Rated Voltage Time: 500 h (+ 24h , - 0h) Then measured after exposure in the room condition for 4 to 24 hours. |
| 8.3 | Heat Life | | Temperature: 85 ± 2 °C Applying Voltage: Rated Voltage × 2 Time: 1000 h (+ 48h , - 0h) Then measured after exposure in the room condition for 24 to 48 hours. |

10. ⚠ Caution

10.1 Limitation of Applications

Please contact us before using our products for the applications listed below which require especially high reliability for the prevention of defects which might directly cause damage to the third party's life, body or property.

- (1) Aircraft equipment (2) Aerospace equipment (3) Undersea equipment (4) Power plant control equipment
- (5) Medical equipment (6) Transportation equipment (automobiles, trains, ships, etc.) (7) Traffic signal equipment
- (8) Disaster prevention / crime prevention equipment (9) Data-processing equipment
- (10) Applications of similar complexity or with reliability requirements comparable to the applications listed in the above

10.2 Corrosive gas

Please refrain from use since contact with environments with corrosive gases (sulfur gas [hydrogen sulfide, sulfur dioxide, etc.], chlorine, ammonia, etc.) or oils (cutting oil, silicone oil, etc.) that have come into contact with the previously stated corrosive gas environment will result in deterioration of product quality or an open from deterioration due to corrosion of product electrode, etc. We will not bear any responsibility for use under these environments.

11. Notice

11.1. Using the block type EMIFIL® (BNX) effectively

This product effectively prevents undesired radiation and external noise from going out / entering the circuit by grounding the high frequency components which cause noise problem. Therefore, grounding condition may affect on the performance of the filter and following attentions should be paid for effective use.

- (1) Design maximized grounding area in the P.C. board, and grounding pattern for all the grounding terminals of the product to be connected. (Recommended to use our recommendation in this spec.)
- (2) Minimize the distance between ground of the P.C. board and the ground plate of the product. (Recommended to use through-hole connection between grounding area both of component side and bottom side.)
- (3) Insert the terminals into the holes on P.C. board completely.
- (4) Don't connect PSG terminal with CG terminal directly. (See the item 4. TERMINAL LAYOUT)

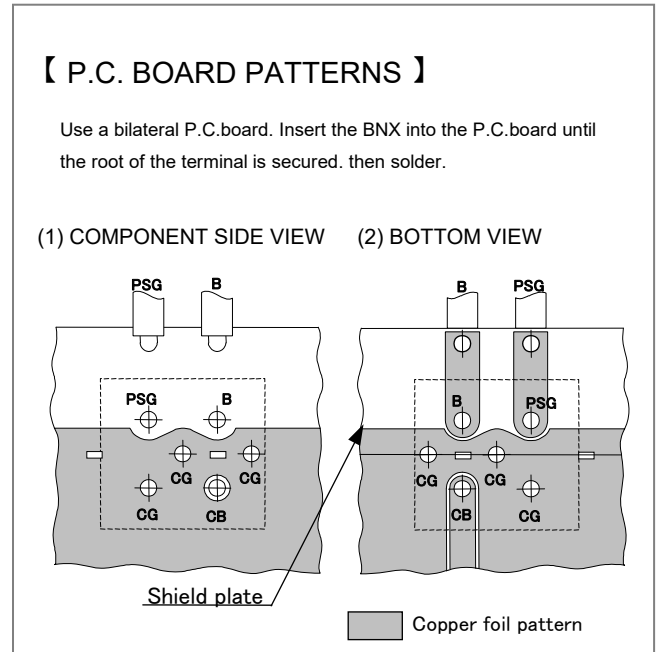

11.2. Self-heating

Though this product has a large rated current, the localized self-heating may be caused depending on soldering conditions. To avoid this, following attention should be paid.

- (1) Use P.C. board with our recommendation on hole diameter / land pattern dimensions, mentioned in the right hand drawing, especially for 4 terminals which pass current.
- (2) Solder the terminals to the P.C. board with solder-cover area at least 90%. Otherwise, excess self-heating at connection between terminals and P.C. board may lead to smoke and / or fire of the product even when operating at rated current.
- (3) After installing this product in your product, please make sure of the self-heating with the rated current.

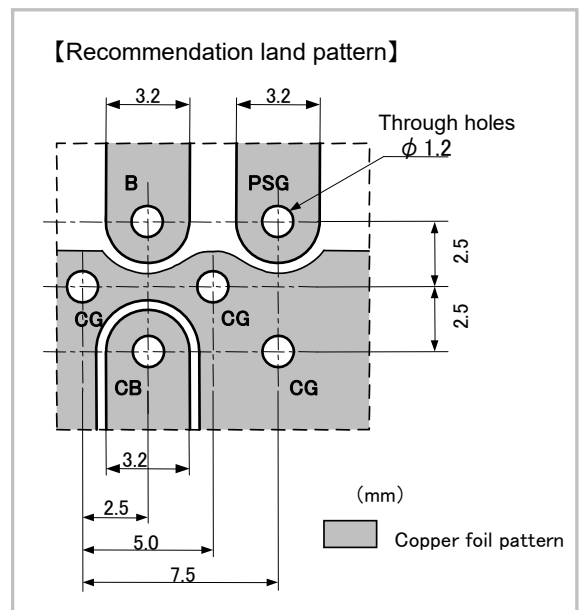

11.3. Soldering

- (1) Flux, Solder
 - Rosin-based flux should be used.
Do not use strong acidic flux with halide content exceeding 0.2(wt)% (chlorine conversion value.)
 - Use Sn-3.0Ag-0.5Cu solder.
- (2) Standard flow soldering profile.

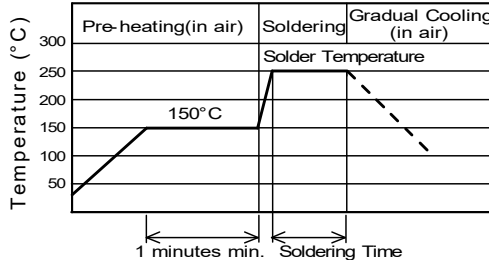

| Solder Temperature | Soldering Time |
|--------------------|----------------|
| 250 ~ 260 °C | 4 ~ 6 s |

- (3) Resistance to soldering iron goes in the following condition that tip temperature is 350 °C max. and soldering time is 5 s max.
- (4) Products and the leads should not be subjected to any mechanical stress during soldering process. (and also while subjected to the equivalent high temperature.)

11.4. Cleaning Conditions

Products shall be cleaned on the following conditions.

- (1) Cleaning temperature shall be limited to 60 °C max. (40 °C max. for IPA.)
- (2) Ultrasonic cleaning shall comply with the following conditions, with avoiding the resonance phenomenon at the mounted products and P.C.B.
Power : 20W / l max. Frequency : 28kHz to 40kHz Time : 5 minutes max.
- (3) Cleaner
 1. Cleaner
 - Isopropyl alcohol (IPA)
 2. Aqueous agent
 - PINE ALPHA ST-100S
- (4) There shall be no residual flux and residual cleaner after cleaning.
In the case of using aqueous agent, products shall be dried completely after rinse with de-ionized water in order to remove the cleaner.
- (5) The surface of products may become dirty whitely after cleaning.
But there is no deterioration on mechanical, electrical characteristics and reliability.
- (6) Other cleaning
Please contact us.

11.5. Operating Environment

- (1) Do not use products in the corrodible atmosphere such as acidic gases, alkaline gases, chlorine, sulfur gases, organic gases and etc. (the sea breeze, Cl₂, H₂S, NH₃, SO₂, NO₂, etc)
- (2) Do not use products in the environment where water, oil or organic solvents may adhere to product.
- (3) Do not use products in the atmosphere where the temperature / humidity changes rapidly and it is easy to dew.

11.6. Storage condition

- (1) Storage period
Use the products within 12 months after delivered.
Solderability should be checked if this period is exceeded.
- (2) Storage environment condition
 - Products should be stored in the warehouse on the following conditions.
Temperature : - 10 °C to + 40 °C
Humidity : 15 % to 85% relative humidity No rapid change on temperature and humidity
 - Don't keep products in corrosive gases such as sulfur, chlorine gas or acid, or it may cause oxidization of electrode, resulting in poor solderability.
 - Products should be stored on the palette for the prevention of the influence from humidity, dust and so on.
 - Products should be stored in the warehouse without heat shock, vibration, direct sunlight and so on.
- (3) Delivery
Care should be taken when transporting or handling product to avoid excessive vibration or mechanical shock.

12. Notes

- (1) Please make sure that your product has been evaluated in view of your specifications with our product being mounted to your product.
- (2) You are requested not to use our product deviating from the reference specifications.
- (3) The contents of this reference specification are subject to change without advance notice. Please approve our product specifications or transact the approval sheet for product specifications before ordering.

Mouser Electronics

Authorized Distributor

Click to View Pricing, Inventory, Delivery & Lifecycle Information:

[Murata:](#)

[BNX002-11](#)